

# K700

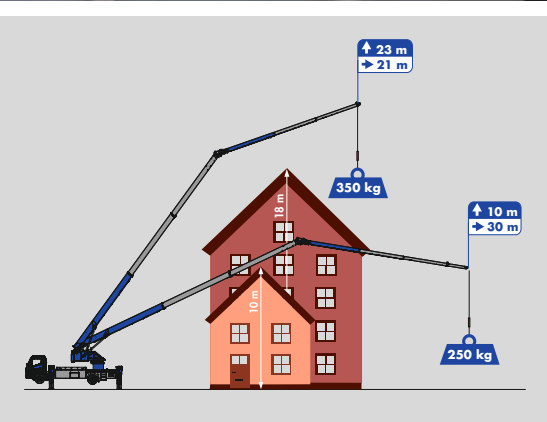

Hakenhöhe **34,5 m** / Ausfahrlänge **36,5 m**

max. Tragkraft **3.000 kg**

2-fach hydraulisch teleskopierbare Klappspitze



**Ausstattung**



Klaas Mastsystem

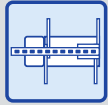

H-Abstützung

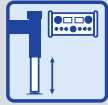

Aufbauautomatik



hydr. teleskopierbare Klappspitze



zwei Klappspitzzylinder



doppelte Wippzylinder

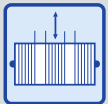

Teleskopierwinde



Ausleger endlos drehbar



Kransteuerung



Funkfernsteuerung



Antriebskonzept



Vollverkleidung



Personensicherungsmodus



Hubarbeitsbühne (opt.)



Zubehör-Fix-System (opt.)



Hybridantrieb (opt.)



Montage-/Glashaken (opt.)

**Technische Informationen**

Hakenlast (stand./optional)	1,6/3,0 t
Hakenhöhe	34,50 m
Ausfahrlänge	36,50 m
Stützbreite (min.)	3,03 m
Stützbreite (max.)	5,29 m
Windenzugkraft	1.600 kg
Ausleger (1.600 kg - 350 kg)	5,00 - 11,65 m

Auszug 3 (250 kg)	13,90 m
LKW* Gesamtgewicht (min.)	≥ 7,49 t

\*abhängig vom jeweiligen LKW-Typ

**Arbeitsbereich**

Last	Reichweite	Höhe
1.600 kg	6,00 m	23,00 m
1.000 kg	14,00 m	17,50 m
750 kg	17,00 m	13,50 m
500 kg	18,00 m	23,00 m
250 kg	30,00 m	10,00 m

**Arbeitsbereich 3t-Funktion\*\***

Last	Reichweite	Höhe
3.000 kg	5,00 m	8,00 m
2.000 kg	6,50 m	5,00 m

\*\*mit Umlenkrolle

**Lastendiagramm\***

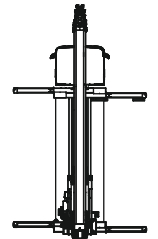
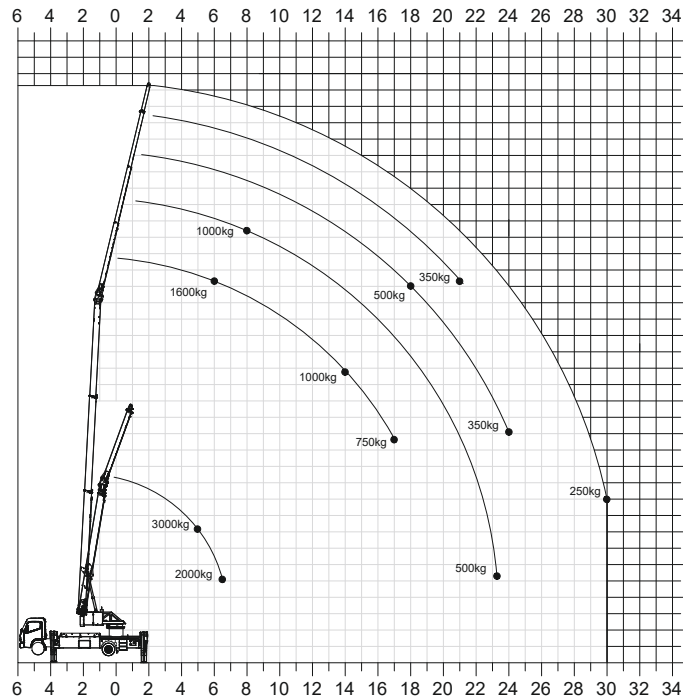

**Bühnenbetrieb\***

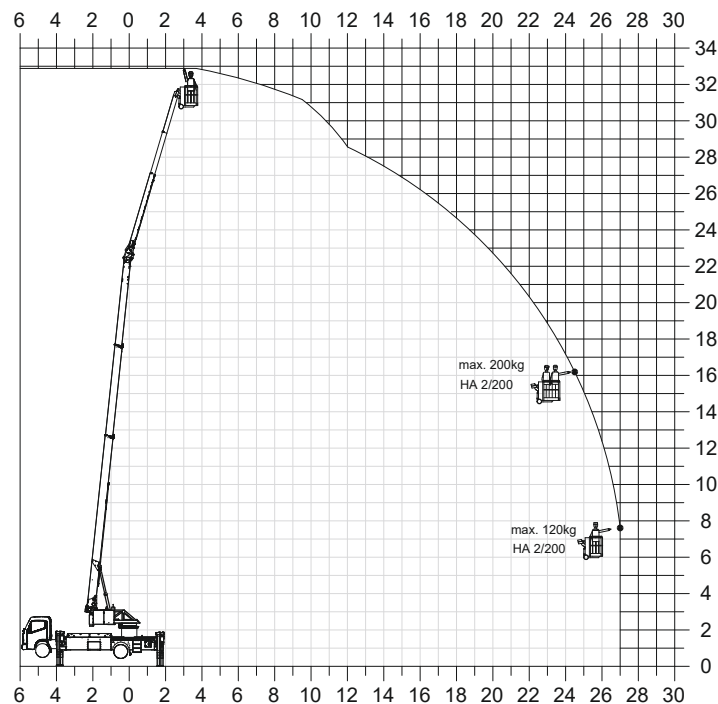

\*Ausladungswerte variieren, je nach Trägerfahrzeug.

Vorbehaltlich technischer Änderungen. Alle Maße sind ca.-Angaben und abhängig vom jeweiligen Trägerfahrzeug. Änderungen der Funktionen und Leistungen bleiben vorbehalten. Die Angaben spiegeln die Geräteleistungen zum Zeitpunkt der Drucklegung wider.

Stand: 09/2021